



EE-SX670/671/672/673/674A/R

Photomicrosensor with Dark-ON Indicator in Variety of Mounting Styles

- New PNP models are now available
- Light-ON operation possible (by short-circuiting the terminals)
- Response frequency as high as 1 kHz
- Wide operating voltage range (5 to 24 VDC) makes smooth connection possible with TTLs, relays, and programmable controllers (PLCs)
- Compact photomicrosensor with a built-in amplifier and special IC makes it possible to directly switch up to 100 mA (NPN versions)
- Circuit integrated into molded housing made of a tough, fiberglass-reinforced PBT resin





Ordering Information

Appearance	Sensing method	Slot width	Slot depth	Output configuration	Weight	Part number
Standard 	Transmissive	5 mm	9 mm	Light-ON/Dark-ON*	Approx. 3.1 g	EE-SX670A EE-SX670R
L-shaped 					Approx. 3.0 g	EE-SX671A EE-SX671R
T-shaped 					Approx. 2.4 g	EE-SX672A EE-SX672R

*These models can be used as Light-ON when the L terminal and positive (+) terminal are connected to each other. To use them as Dark-ON, do not connect these terminals to each other. Connector EE-1001 can be used for Light-ON operation.

(This table continues on the next page.)

Ordering Information Table - continued from previous page

Appearance	Sensing method	Slot width	Slot depth	Output configuration	Weight	Part number
	Transmissive	5 mm	9 mm	Light-ON/Dark-ON*	Approx. 2.3 g	EE-SX673A EE-SX673R
				Light-ON/Dark-ON	Approx. 3.0 g	EE-SX674A EE-SX674R

*These models can be used as Light-ON when the L terminal and positive (+) terminal are connected together. To use them as Dark-ON, do not connect these terminals to each other. Connector EE-1001 can be used for Light-ON operation.

Specifications

RATINGS

Item		Standard	L-shaped	T-shaped	Close-mounting
	NPN output	EE-SX670A	EE-SX671A	EE-SX672A	EE-SX673A EE-SX674A
	PNP output	EE-SX670R	EE-SX671R	EE-SX672R	EE-SX673R EE-SX674R
Supply voltage		5 to 24 VDC $\pm 10\%$, ripple (p-p): 10% max.			
Current consumption		NPN models: 35 mA max., PNP models: 30 mA max.			
Slot width		5 mm			
Standard reference object		Opaque: 2 x 0.8 mm			
Differential distance		0.025 mm			
Control output		NPN open collector output models: At 5 to 24 VDC: 100 mA load current (I_C) with a residual voltage of 0.8 V max. When driving TTL: 40 mA load current (I_C) with a residual voltage of 0.4 V max. PNP open collector output models: At 5 to 24 VDC: 50 mA load current (I_C) with a residual voltage of 1.3 V max.			
Output configuration	Transistor on output stage without detecting object	OFF (ON if set to Light-ON)			
	Transistor on output stage with detecting object	ON (OFF if set to Light-ON)			
Indicator*	Without detecting object	OFF			
	With detecting object	ON			
Response frequency**		1 kHz max. (3 kHz typ.)			
Light source		GaAs infrared LED with a peak wavelength of 940 nm			
Receiver		Si photo-transistor with a sensing wavelength of 850 nm max.			
Connecting method		EE-1001/1006 Connectors; soldering terminals			

*The indicator is GaP red LED (peak emission wavelength: 690 nm).

**The response frequency was measured by detecting the following disks rotating.

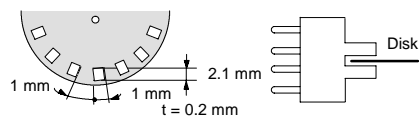

CHARACTERISTICS

Ambient illumination*		Fluorescent light: 1,000 lx max.
Ambient temperature	Operating	-25°C to 55°C (-13°F to 131°F)
	Storage	-30°C to 80°C (-22°F to 176°F)
Ambient humidity	Operating	5% to 85%
	Storage	5% to 95%
Vibration resistance		Destruction: 20 to 2,000 Hz, (with a peak acceleration of 10G's), 1.5-mm double amplitude for 2 hrs (with 4-minute cycles) each in X, Y, and Z directions
Shock resistance		Destruction: 500 m/s ² for 3 times each in X, Y, and Z directions
Soldering heat resistance**		260±5°C when the portion between the tip of the terminals and the position 1.5 mm to the terminal base is dipped into the solder for 10±1 seconds
Degree of protection		IEC 60529, IP50
Materials	Case	Polybutylene phthalate (PBT)
	Cover	Polycarbonate (PC)
	Emitter/Receiver	Polycarbonate (PC)

*The ambient luminance is measured on the surface of the receiver.

**This conforms to MIL-STD-750-2031-1.

Engineering Data

SENSING POSITION CHARACTERISTICS (TYPICAL)

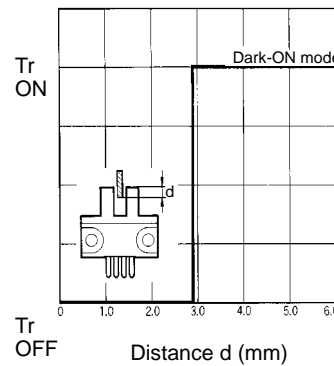
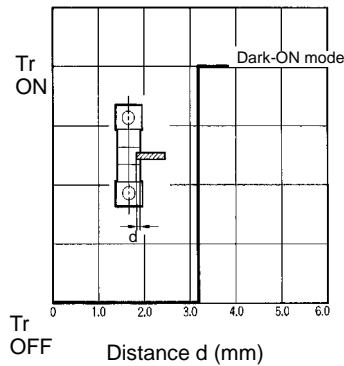

REPEATED SENSING POSITION CHARACTERISTICS (TYPICAL)

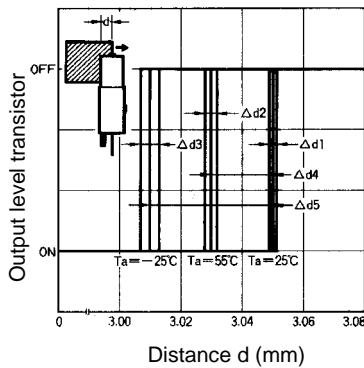

No. of repetitions: 20 at V_{CC} = 12 V

- Δd1 = 0.002 mm
- Δd2 = 0.004 mm
- Δd3 = 0.005 mm
- Δd4 = 0.02 mm
- Δd5 = 0.04 mm

Operation

INTERNAL/EXTERNAL CIRCUIT DIAGRAM

Light-ON/Dark-ON

NPN Output

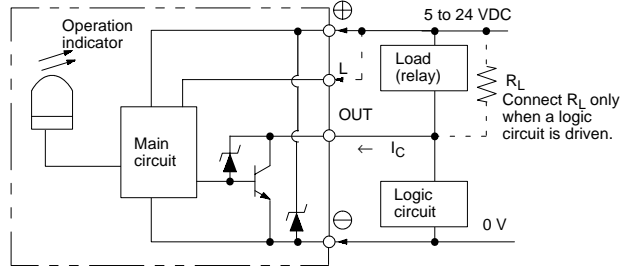

PNP Output

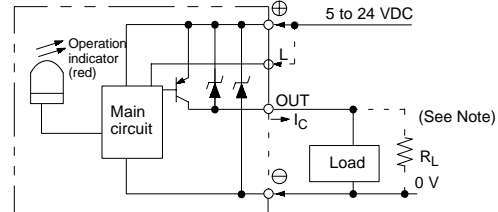

Note: When using a voltage output, always insert a resistor in R_L .

TIMING CHART

Light-ON

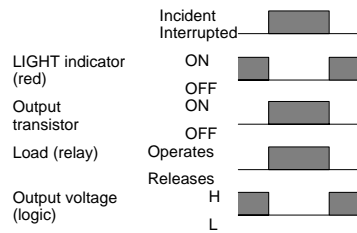

Dark-ON

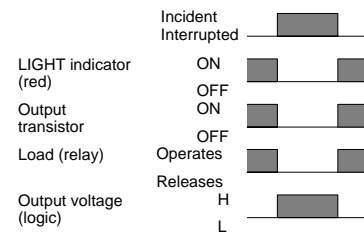

Dimensions

Unit: mm (inch)

EE-SX670A/R

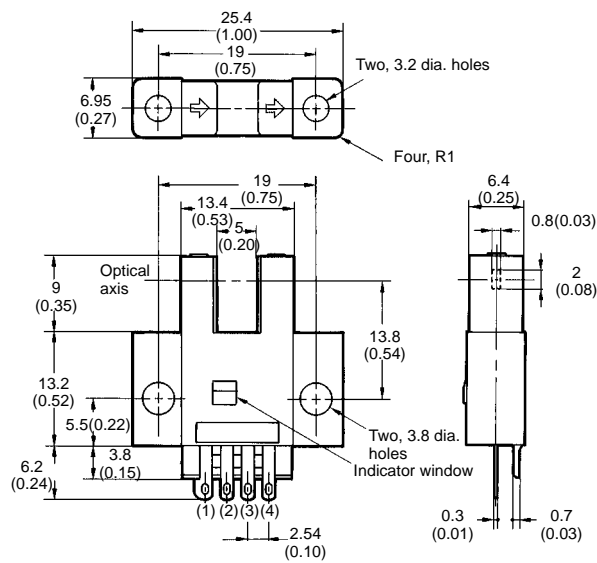
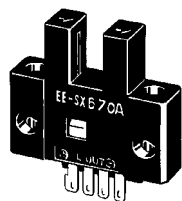

Terminal Arrangement

(1)	⊕	V _{CC}
(2)	L	L
(3)	OUT	OUTPUT
(4)	⊖	GND (0 V)

■ EE-SX671A/R

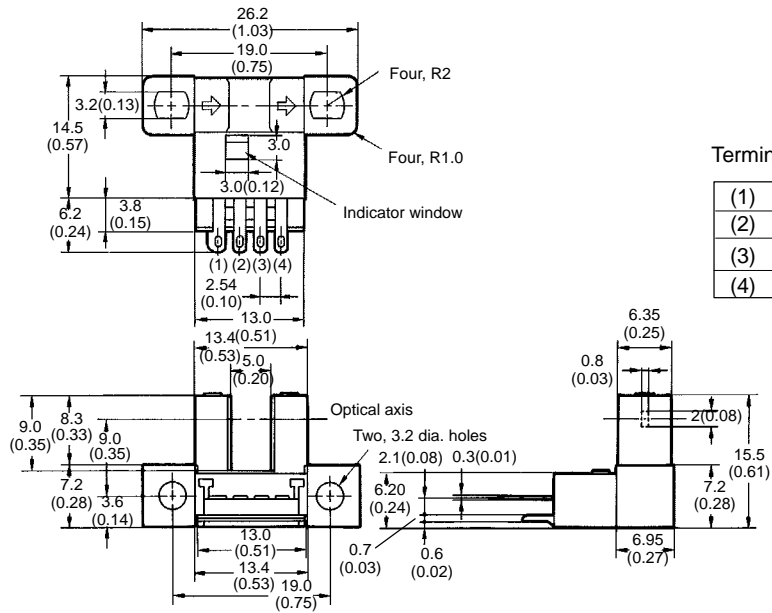
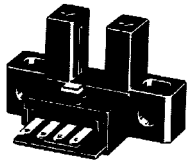

Terminal Arrangement

(1)	⊕	V _{CC}
(2)	L	L
(3)	OUT	OUTPUT
(4)	⊖	GND (0 V)

■ EE-SX672A/R

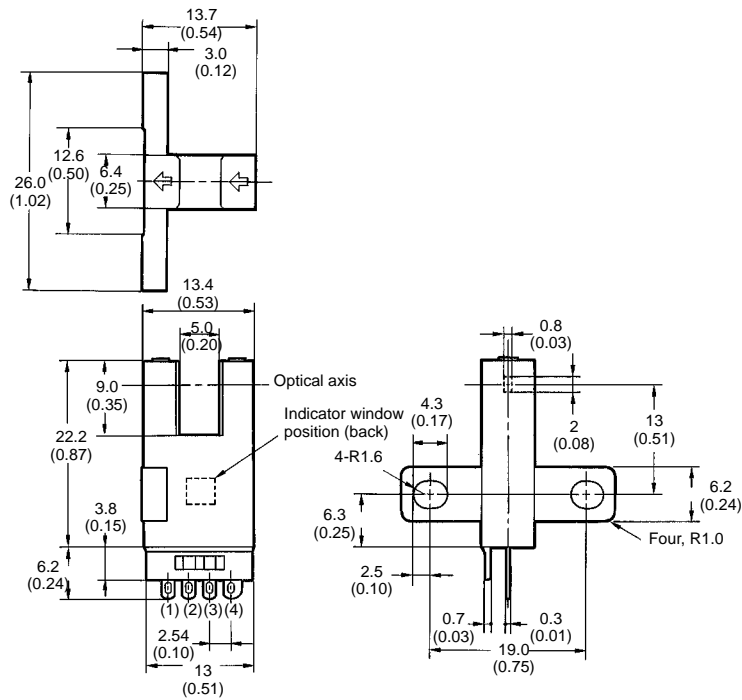
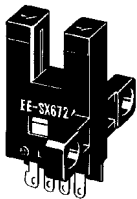

Terminal Arrangement

(1)	⊕	V _{CC}
(2)	L	L
(3)	OUT	OUTPUT
(4)	⊖	GND (0 V)

■ EE-SX673A/R

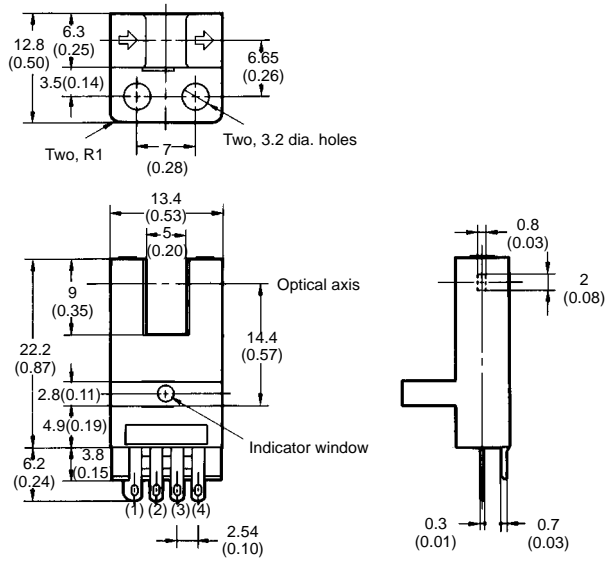

Terminal Arrangement

(1)	⊕	V _{CC}
(2)	L	L
(3)	OUT	OUTPUT
(4)	⊖	GND (0 V)

■ EE-SX674A/R

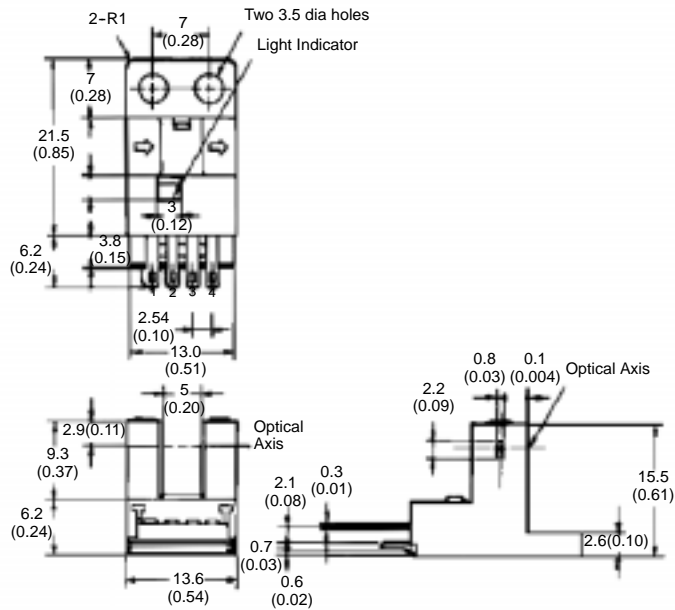
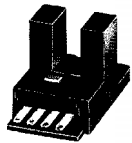

Terminal Arrangement

(1)	⊕	V _{CC}
(2)	L	L
(3)	OUT	OUTPUT
(4)	⊖	GND (0 V)

■ EE-1001 CONNECTOR

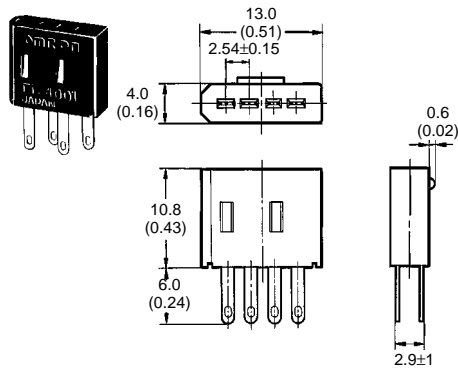

■ EE-SX67□A/R WITH EE-1001 CONNECTOR

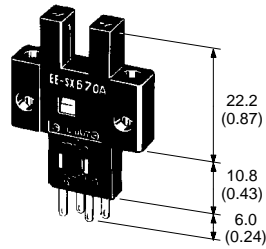

■ EE-1006 CONNECTOR WITH CABLE

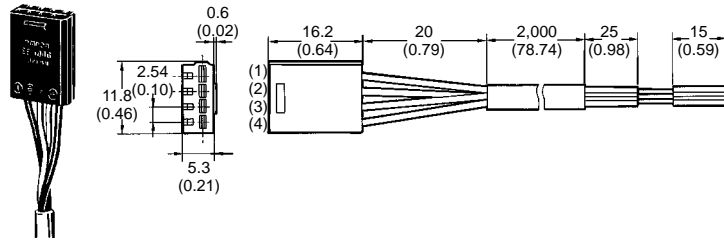

Terminal Arrangement - IEC Colors

(1)	Brown (Red)	⊕	V _{CC}
(2)	Pink (Yellow)	L	L
(3)	Black (White)	OUT	OUTPUT
(4)	Blue (Black)	⊖	GND (0 V)

Note: Older standard colors are shown in parentheses. Connector comes with a 2-m attached cable.

■ EE-1006A CONNECTOR HOLDER

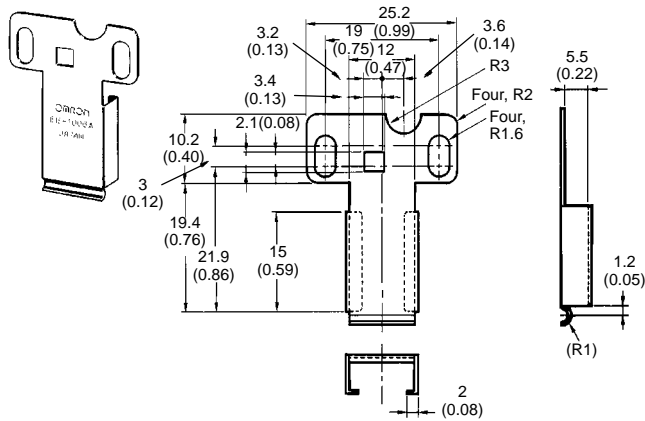

Precautions

Refer the Technical Information Section for general precautions.

The sensing window is made of a polycarbonate resin which withstands chloride solvents and strong acids but is soluble in strong alkali, aromatic hydrocarbons, and aliphatic hydrocarbonate chloride solvents.

The casing material uses a PBT resin but is soluble in strong alkali solvents.

The temperature of the terminals at the time of soldering must not exceed the characteristics found in the table provided here:

Item	Temperature	Permissible time	Remarks
Dip	260°C	10 sec	The portion between the base of the terminals and the position 1.5 mm from the terminal base must not be soldered.
Iron	350°C	3 sec	

The terminal base uses a polycarbonate resin, which could be deformed by excessive soldering heat.

NOTE: DIMENSIONS SHOWN ARE IN MILLIMETERS. To convert millimeters to inches divide by 25.4.

OMRON[®]
OMRON ELECTRONICS, INC.
 One East Commerce Drive
 Schaumburg, IL 60173
1-800-55-OMRON

OMRON CANADA, INC.
 885 Milner Avenue
 Scarborough, Ontario M1B 5V8
416-286-6465